

SAVIN 9940DP

Operating Instructions

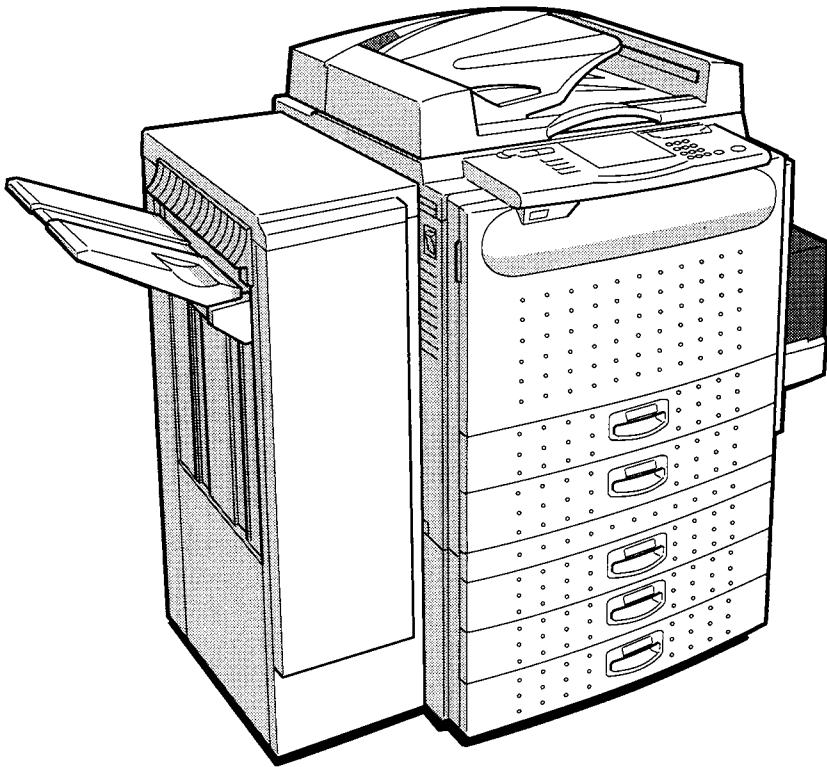

Operator Safety:

This copier is considered a CDRH class I laser device, safe for office/EDP use. The Copier contains a 15-milliwatt, 760-800 nanometer wavelength, GaAlAs laser diode. Direct (or indirect reflected) eye contact with the laser beam may cause serious eye damage. Safety precautions and interlock mechanisms have been designed to prevent any possible laser beam exposure to the operator.

Laser Safety:

The Center for Devices and Radiological Health (CDRH) prohibits the repair of laser-based optical unit in the field. The optical housing unit can only be repaired in a factory or at a location with the requisite equipment. The laser subsystem is replaceable in the field by a qualified Customer Engineer. The laser chassis is not repairable in the field. Customer engineers are therefore directed to return all chassis and laser subsystems to the factory or service depot when replacement of the optical subsystem is required.

Warning:

Use of controls or adjustment or performance of procedures other than those specified in this manual may result in hazardous radiation exposure.



As an Energy Star Partner, we have determined that this copier model meets Energy Star Guidelines for energy efficiency.

This product was designed to reduce the environmental impact associated with copying equipment by means of energy saving features such as Auto Off, Low Power, and Duplex Mode Priority modes.

For details, see the following pages.

- ❖ Auto Off Mode : see page 138.
- ❖ Low Power Mode : see page 137.
- ❖ Duplex Mode Priority : see page 141.

Two kinds of size notation are employed in this manual. With this machine refer to the inch version.

For good copy quality, Savin recommends that you use genuine Savin toner.

Savin shall not be responsible for any damage or expense that may result from the use of parts other than genuine Savin parts in your Savin office product.

Note: Some illustrations may be slightly different from your machine.

Note: Certain options may not be available in some countries. For details, please contact your local dealer.

Power Source: 120 V, 60 Hz, more than 12A

Please make sure to connect the power cord to a power source as above. For details about power source, see page 160.

Recycled paper:

Please contact your sales or service representative for recommended recycled paper types that may be used in this copier.

INTRODUCTION

This manual contains detailed instructions on the operation and maintenance of this copier. To get maximum versatility from this copier all operators should carefully read and follow the instructions in this manual. Please keep this manual in a handy place near the machine.

Please read the next section before using this copier. It contains important information related to USER SAFETY and PREVENTING EQUIPMENT PROBLEMS.

SAFETY INFORMATION

When using your copier, the following safety precautions should always be followed.

Safety During Operation

In this manual, the following important symbols are used:



This symbol is intended to alert the user to the presence of important operating and maintenance (servicing) instructions in the literature accompanying the machine.



This symbol is attached to some components to alert the user not to touch them, because they may be very hot.

In addition, all safety messages are identified by the words "WARNING" and "CAUTION". These words mean the following:

⚠ WARNING: *Important information to alert you to a situation that might cause serious injury and damage to your property if instructions are not followed.*

⚠ CAUTION: *Important information that tells how to prevent damage to equipment, or how to avoid a situation that might cause minor injury.*

⚠ WARNINGS:

Since some parts of the copier are supplied with high voltage, touch only the parts specified in this manual.

Do not modify or replace any parts other than the ones specified in this manual.

Do not incinerate toner or toner containers. Toner dust might ignite when exposed to open flames.

Do not store toner where it will be exposed to heat.

Do not eat or swallow toner, and keep it out of reach of children.

The fusing unit may be very hot. Be careful when handling it.

⚠ CAUTIONS:

While copying, do not turn off the main switch.

While copying, do not open the front cover.

While copying, do not unplug the power cord.

While copying, do not lift the platen cover, or the document feeder.

Do not lay anything weighing more than 10 kg (22 lb) on the exposure glass.

Keep corrosive liquids, such as acid, off the machine.

Do not allow paper clips, staples, or other small metallic objects to fall inside the machine.

General Safety Information

- ❑ Always turn the copier off when you have finished copying for a day, but leave it plugged in.
- ❑ When the copier will not be used for a long period, disconnect the power cord.
- ❑ If the copier must be transported by vehicle, please contact your service representative.
- ❑ When the main switch is in the Stand-by position, the optional heaters are on. In case of emergency, unplug the machine's power cord.
- ❑ To disconnect the power source, the main plug must be pulled.

TABLE OF CONTENTS

WHERE IS IT & WHAT IS IT

SYSTEM OVERVIEW	3
COPIER EXTERIOR & INTERIOR	4
OPERATION PANEL	6
Hard Keys	6
Touch Panel Display.....	8

WHAT YOU CAN DO WITH THIS COPIER

FUNCTIONS	12
without optional finisher	12
with optional finisher	12

BASICS

STARTING THE COPIER	24
When The Main Switch Is In The Stand-by Position	24
When The Display Is Off And The Indicator Of The Clear Modes/Low Power Mode Key Is Lit	24
When The Copier Is Set For User Codes.....	25
USING THE TOUCH PANEL DISPLAY	26
GETTING HELP ON THE DISPLAY	28
RECOMMENDED & NON-RECOMMENDED ORIGINALS	29
Recommended Originals	29
Non-recommended Originals For The Optional Document Feeder	29
SETTING ORIGINALS ON THE EXPOSURE GLASS	30
SETTING A STACK OF ORIGINALS IN THE OPTIONAL DOCUMENT FEEDER (ADF)	30
SETTING ONE ORIGINAL AT A TIME IN THE OPTIONAL DOCUMENT FEEDER (SADF)	32

COPYING

BASIC OPERATIONS	36
One-to-one Copying (Full Size Copying)	36
Entering Copy Job Settings During The Warm-up Period (Auto Start)	37
Adjusting Copy Image Density	37
Selecting The Copy Paper Size (Manual Paper Select).....	38
Having The Copier Choose The Paper Size(Auto Paper Select).....	39
Having The Copier Choose The Reproduction Ratios (Auto Reduce/Enlarge).....	41
Selecting Original Type Setting (Letter, Letter/Photo, Photo, Generation Copy).....	43
Sorting Into Sets (123,123,123) (Sort, Rotate Sort)	44
Stacking Together All Copies Of A Page (111,222,333) (Rotate Stack) ..	48
Copying From The Bypass Tray	50
Temporarily Stopping One Job To Copy Something Else (Interrupt).....	53
Recalling Job Settings (Job Recall)	53
Storing Your Copy Setting In Memory (Program).....	54
REDUCING AND ENLARGING (Reduce/Enlarge)	55
Reducing And Enlarging Using Preset Ratios (Preset R/E)	55
Reducing And Enlarging In 1% Steps	56
Fitting The Original To A Copy Of A Different Size.....	58
WORKING WITH BOTH SIDES OF ORIGINALS AND COPIES (Duplex/Series Copies).....	61
Making Two-sided Copies (Duplex)	61
Making One-sided Copies (Series Copies).....	68
COMBINING ORIGINALS INTO ONE COPY (Combine)	70
PRINTING ID NUMBERS, PAGE NUMBERS, AND MESSAGES (Stamp) 74	
Printing Numbers On The Background Of Your Copies (Background Numbering)	74
Printing Preset Messages On Your Copies (Auto Stamping) - English Only.....	75
Printing Your Own Messages On Your Copies (User Stamping).....	79
Printing Dates And Page Numbers (Date Stamping, Page Numbering)	81

TABLE OF CONTENTS

EDITING THE COPY IMAGE (Adjust Image)	86
Copying The Image Twice On One Page (Double Copies).....	86
Erasing The Center And The Border (Erase Center/Border).....	88
Adjusting The Margin (Margin Adjustment).....	89
Repeating An Image Over The Entire Copy (Image Repeat).....	91
Reversing Black and White (Positive/Negative).....	93
Merging Images (Overlay/Merge).....	94
OPTIONAL FINISHING	96
Sorting Into Sets (123,123,123) (Sort)	96
Stapling (Staple)	100
Stapling Position And Original Setting	101
When Setting One Original At A Time	104
When Setting A Stack Of Originals In The Document Feeder	104
COMBINATION CHART	105
WHAT TO DO IF SOMETHING GOES WRONG	
IF YOUR COPIER DOES NOT OPERATE AS YOU WANT	110
IF YOU CANNOT MAKE CLEAR COPIES	112
IF YOU CANNOT MAKE COPIES AS YOU WANT	113
LOADING PAPER	117
Non-recommended Paper	117
Notes For Paper	117
Loading Paper In The Paper Tray.....	118
Loading Paper In The Large Capacity Tray.....	119
ADDING TONER	120
ADDING STAPLES	121
CLEARING MISFEEDS	122
Check The Display	122
When Misfeeds Occur In A, B, C, Y, Or Z Section.....	123

TABLE OF CONTENTS

When Misfeed Occurs At The Large Capacity Tray 123
When Misfeed Occurs In P Section 124
When Misfeeds Occur In R Section 124
REMOVING JAMMED STAPLES 125

CHANGING THE COPIER'S SETTINGS

CHANGING PAPER SIZE 128
 Changing Paper Size In The 1st Tray 128
 Changing The Paper Size In The Optional Tray Unit (Trays 2, 3, and 4) .. 133
USER TOOLS 134
 User Tools Menu 134
 How To Change The Basic Settings And Copy Features 136
 Basic Settings 137
 Copy Features 141
 How To Register User Stamp 152
SERVICE REPRESENTATIVE SETTINGS 153

**MAINTAINING YOUR COPIER
DO'S AND DON'TS
REMARKS
WHERE TO PUT YOUR COPIER
USE AND STORAGE OF SUPPLIES**

MAINTAINING YOUR COPIER 156
 Copier 156
 Document Feeder (Option) 156
DO'S AND DON'TS 157
 Copier 157
 Document Feeder (Option) 158
 Finisher (Option) 158
REMARKS 159
 Copier 159
WHERE TO PUT YOUR COPIER 160
 Copier Environment 160
 Power Connection 160

TABLE OF CONTENTS

Access To The Copier..... 161

USE AND STORAGE OF SUPPLIES..... 162

 Copy Paper..... 162

 Paper Storage..... 163

 Toner Storage..... 163

SPECIFICATIONS

COPIER..... 166

DOCUMENT FEEDER (OPTION) 169

FINISHER (OPTION) 170

1000-SHEET TRAY UNIT (OPTION) 171

1500-SHEET TRAY UNIT (OPTION) 171

INDEX

INDEX 174

WHERE IS IT & WHAT IS IT

WHERE IS IT & WHAT IS IT

SYSTEM OVERVIEW	3
COPIER EXTERIOR & INTERIOR	4
OPERATION PANEL	6
Hard Keys	6
Touch Panel Display	8

SYSTEM OVERVIEW

WHERE IS IT & WHAT IS IT

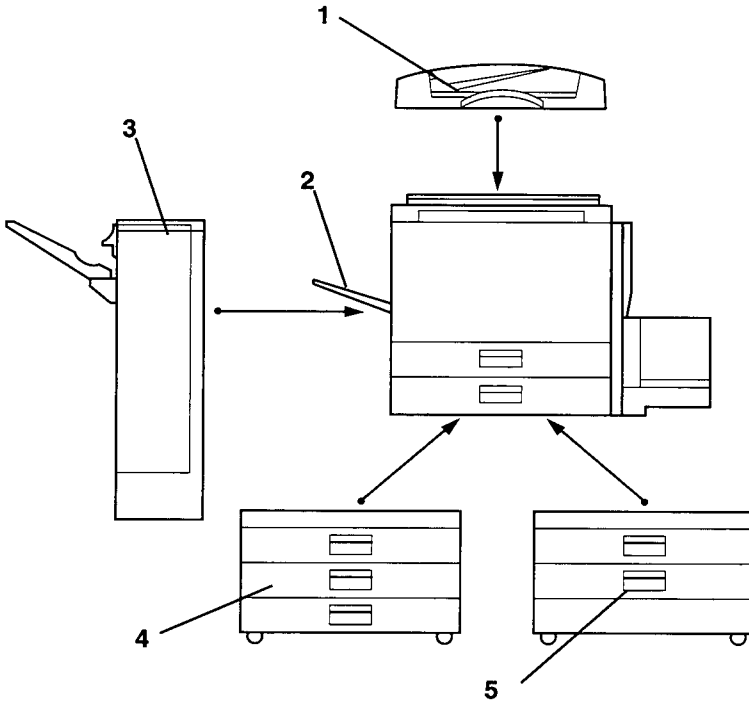

- | | |
|---|---|
| 1. Document feeder
(Option) | Insert a stack of originals here. They will be fed automatically. |
| 2. Copy tray
(Option) | Completed copies are delivered here. |
| 3. Finisher
(Option) | Sorts, stacks, and staples copies. |
| 4. 1500-sheet tray unit
(Option) | Holds 1500 sheets of copy paper. |
| 5. 1000-sheet tray unit
(Option) | Holds 1000 sheets of copy paper. |

Other options: platen cover and key counter

COPIER EXTERIOR & INTERIOR

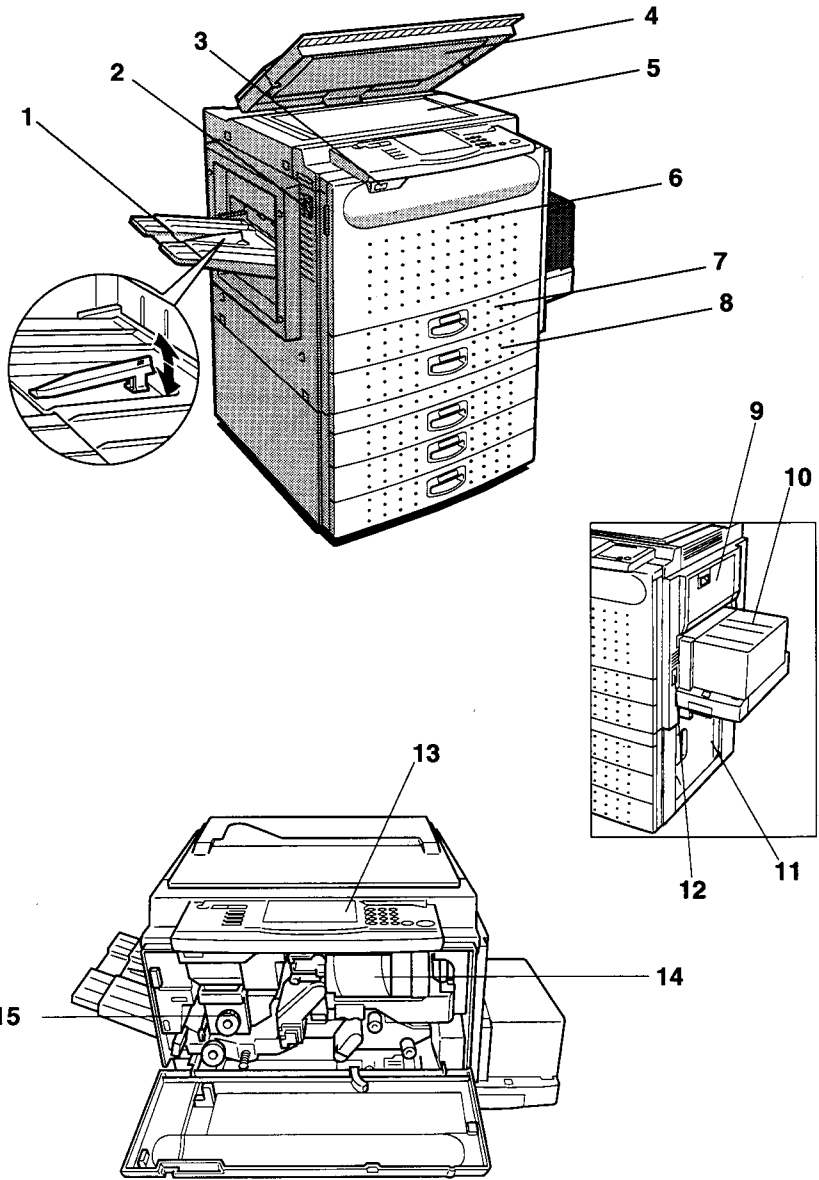

1. **Copy tray (option)** Completed copies are delivered here. Regarding the capacity of the tray, see page 166.
2. **Main switch** Switches the copier between on and standby conditions.
3. **Auto response (human) sensor** When someone comes close to the copier, it will automatically switch from Low Power mode to standby mode.
4. **Platen cover (option)** Lower this cover over originals for copying.
5. **Exposure glass*** Position originals here face down for copying.
*After turning off the main switch, the exposure glass might be hot because of the anticondensation function. This is not a problem.
6. **Front cover** Open to access the inside of the copier.
7. **Unit for two-sided copies (Duplex unit)** Makes two-sided copies.
8. **Paper tray** Holds 500 sheets of copy paper.
9. **Bypass tray** Use to copy onto OHP sheets, adhesive labels, translucent paper, post cards, and non-standard size paper.
10. **Large capacity tray** Holds 1,000 sheets of copy paper.
11. **Right cover of the optional tray unit** Open to remove misfed paper.
12. **Key counter holder** Insert the optional key counter here.
13. **Operation panel** Operator controls and touch panel are located here. See the next page.
14. **Toner bottle** Replace the toner bottle when "  Add Toner" is displayed on the display. See page 120.
15. **Fusing unit** Fuses the copy image to the paper. When accessing the inside of the copier, use caution. This unit may be very hot.

OPERATION PANEL

Hard Keys

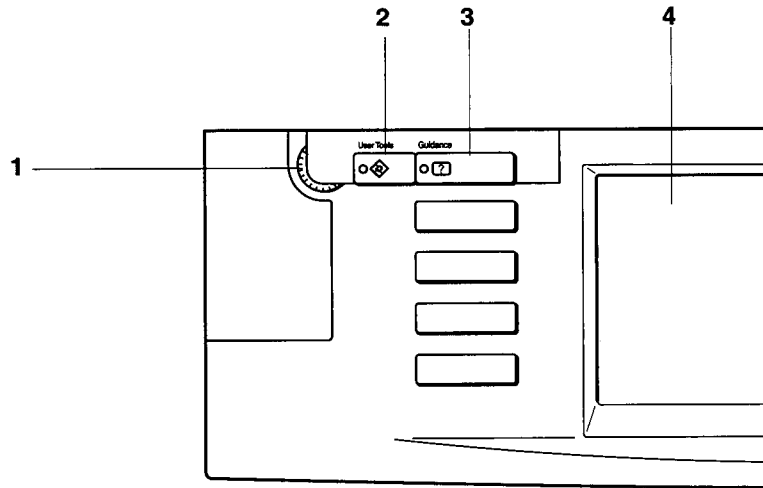

1. Contrast Dial

Changes the brightness of the display.

2. User Tools key

Changes the basic settings and copy features. ➤ See page 134.

3. Guidance key

Shows guidance for functions.
➤ See page 28.

4. Touch Panel Display

➤ See page 26.

5. Program key

Press to select the program mode. ➤ See page 54.

6. Job Recall key

Use to recall your previous copy settings. ➤ See page 53.

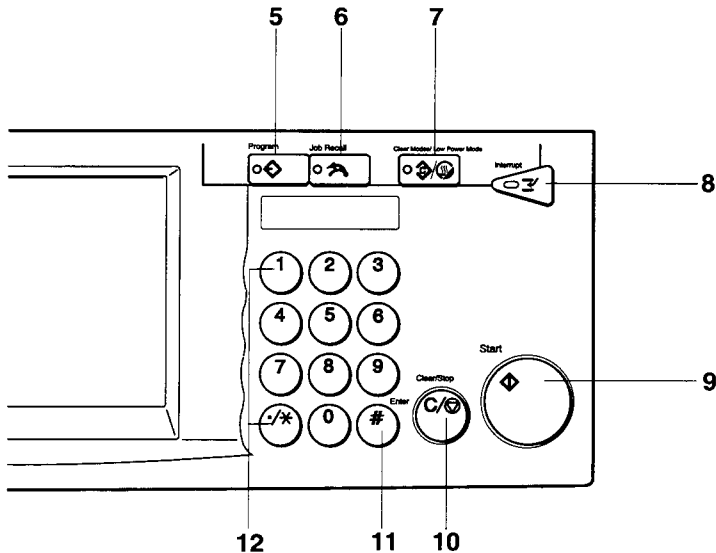

7. Clear Modes/Low Power Mode key

Press to clear the previously entered copy job settings. Also use to switch to and from Low Power mode. See pages 24 and 137.

8. Interrupt key

Press to make interrupt copies during a copy run.

See page 53.

9. Start key

Press to start copying. Use to set the Auto Start. See page 37.

10. Clear/Stop key

While entering numbers, press to cancel a number you have entered. While copying, press to stop copying.

11. Enter key

Use to enter data in selected modes.

12. Number keys

Use to enter the desired number of copies and data for selected modes.

Touch Panel Display

without optional finisher

Message area

Copier status and messages

Original Counter

Number of originals scanned so far.

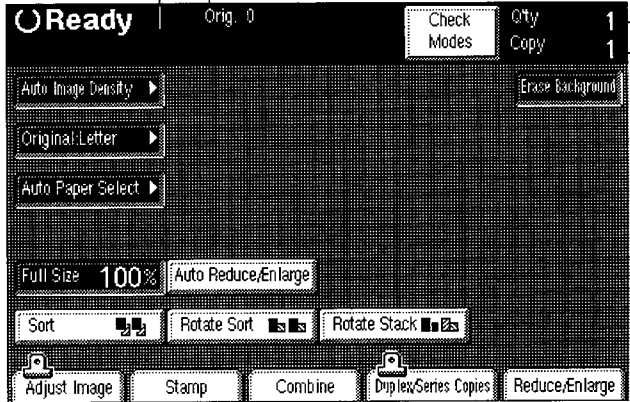

Copy Set Total
Total number of copy sets entered.

Copy Set Counter
Number of copy sets made so far.

with optional finisher

Message area

Original Counter

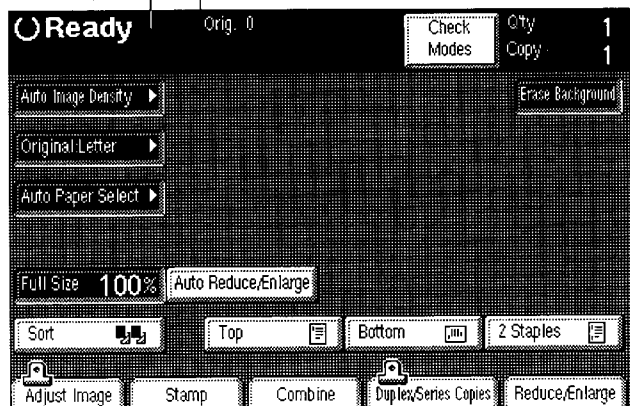

Copy Set Total

Copy Set Counter

- ❑ Regarding detailed information about each key and its functions, see page 12.
- ❑ For how to use the touch panel display, see page 26.

To save paper resources, the following modes are selected as a default setting as shown on the previous page.

[Duplex/Series Copies]

Duplex (from one-sided originals to two-sided copies)

Number of originals: Even

Orientation: Top to Top

[Adjust Image]

Margin Adjustment

(0.2" width margin for right side of back side)

- ❑ You can change the above default setting with the user tools. See pages 141 and 143.
- ❑ To change the Duplex mode settings, touch the **[Duplex/Series Copies]** key and change the setting.
- ❑ To change the Margin Adjustment settings, touch the **[Adjust Image]** key and change the setting.

OPERATION PANEL

WHAT YOU CAN DO WITH THIS COPIER

WHAT YOU CAN DO WITH
THIS COPIER

FUNCTIONS

without optional finisher

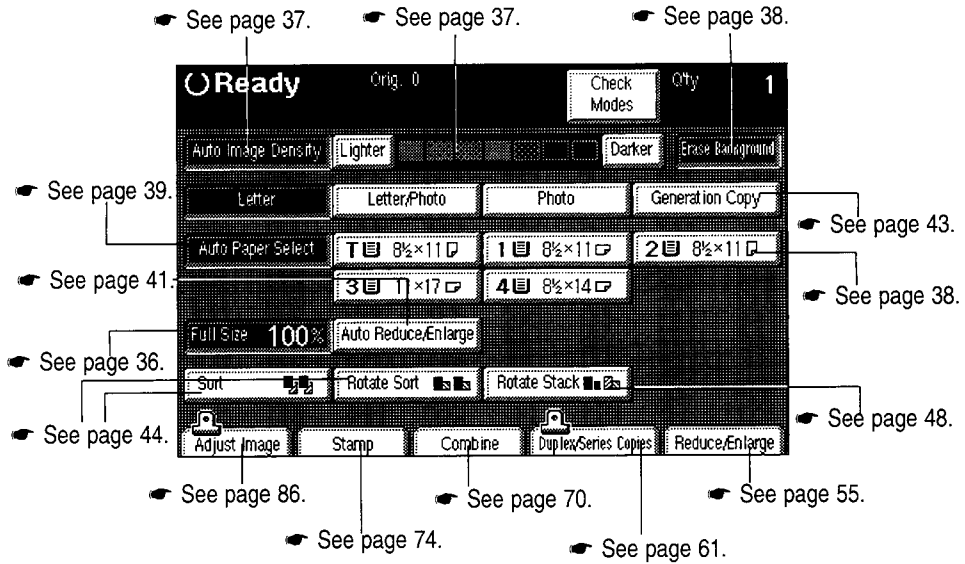

with optional finisher

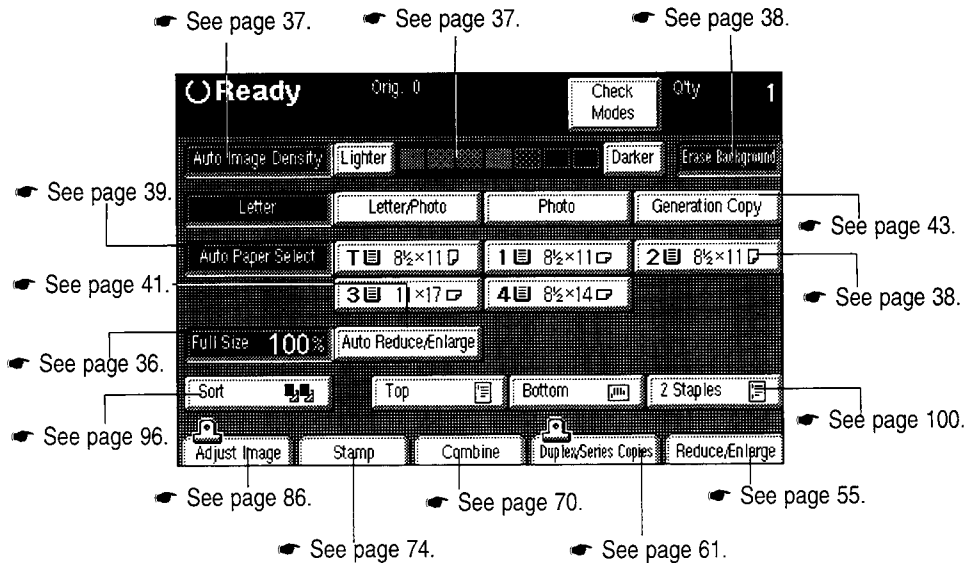

Getting Help On The Display

➤ See page 28.

Adjusting Copy Image Density

➤ See page 37.

Having The Copier Choose The Paper Size

➤ See page 39.

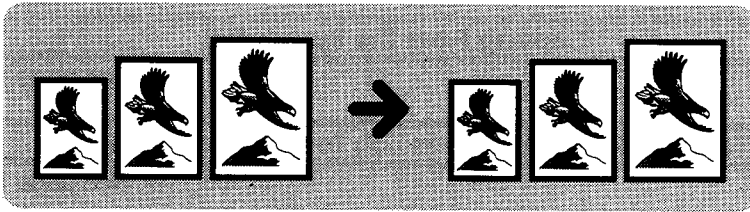

Having The Copier Choose The Reproduction Ratios

➤ See page 41.

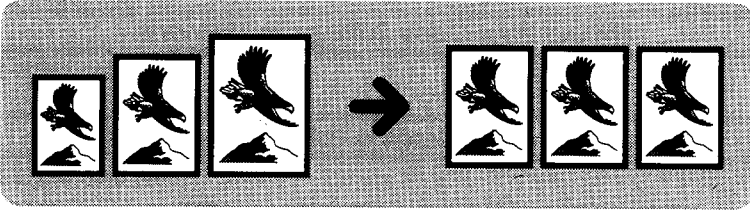

Selecting Original Type Setting

➤ See page 43.

Sorting Into Sets

➤ See page 44.

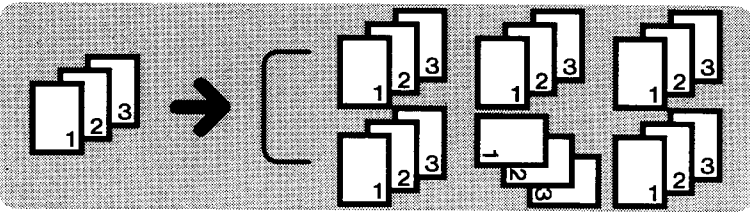

WHAT YOU CAN DO WITH
THIS COPIER

Stacking Together All Copies Of A Page

☛ See page 48.

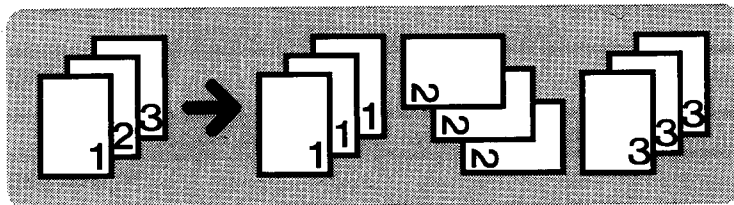

Copying From The Bypass Tray

☛ See page 50.

Temporarily Stopping One Job To Copy Something Else

☛ See page 53.

Recalling Job Settings

☛ See page 53.

Storing Your Copy Settings In Memory

☛ See page 54.

Reducing And Enlarging Using Preset Ratios

☛ See page 55.

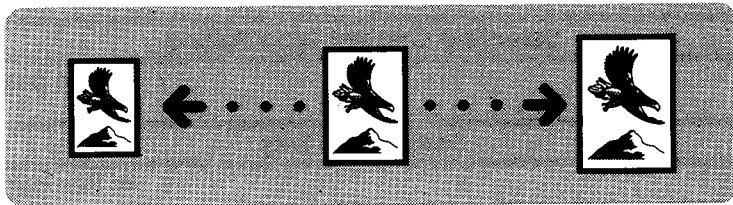

Reducing And Enlarging In 1% Steps

☛ See page 56.

Using the [+] and [-] keys or Number keys

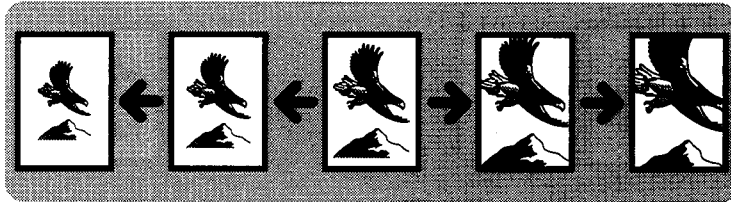

Stretching and squeezing the image

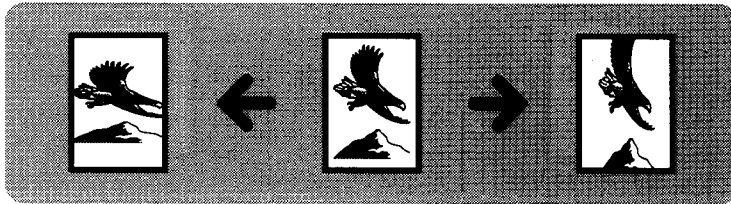

Fitting The Original To A Copy Of A Different Size

☛ See page 58.

Fitting the image in the copy area as it is

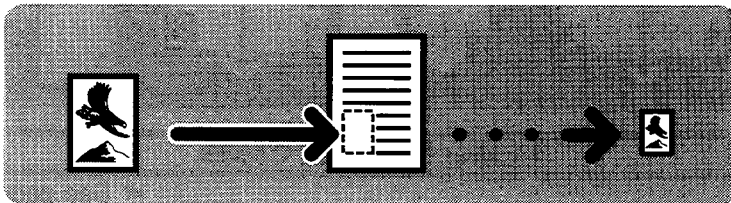

Stretching and squeezing the image into the copy area

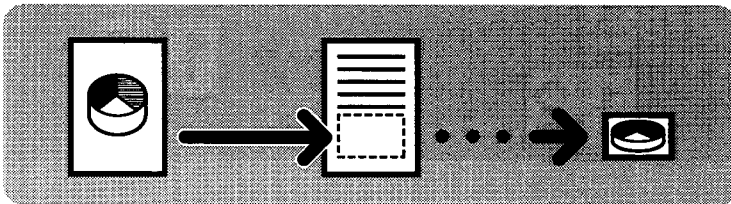

WHAT YOU CAN DO WITH THIS COPIER

Making Two-sided Copies

• See page 61.

From one-sided originals

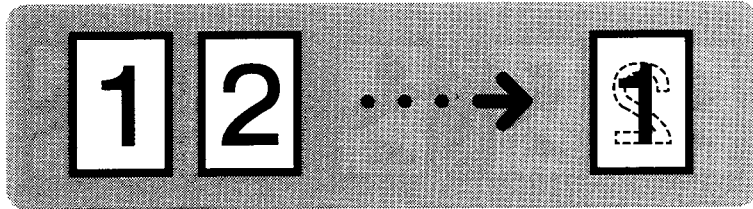

From two-sided originals

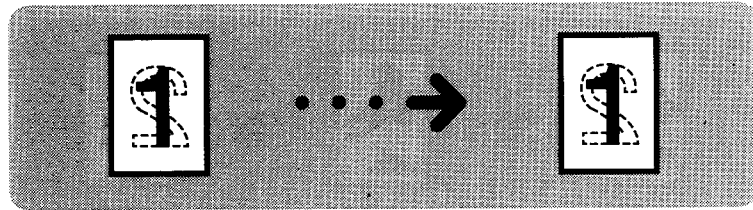

From book originals (Single)

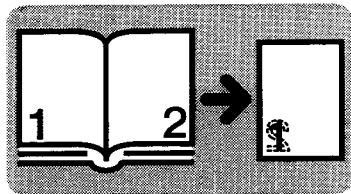

(Multi)

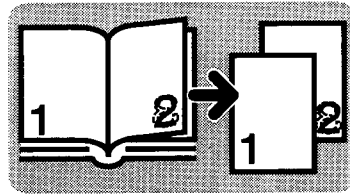

Making One-sided Copies

• See page 68.

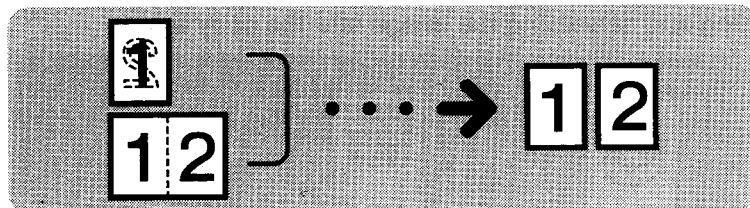

Combining Originals Into One Copy

☛ See page 70.

From 2 one-sided originals

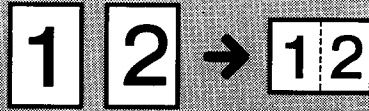

From 4 one-sided originals

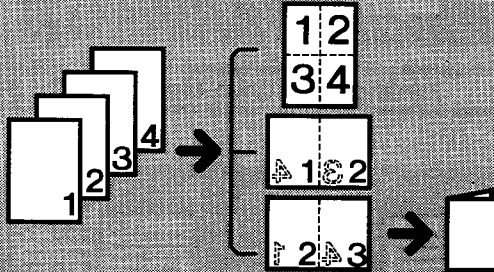

From 8 one-sided originals

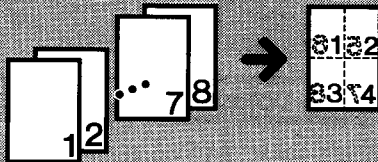

From 16 one-sided originals

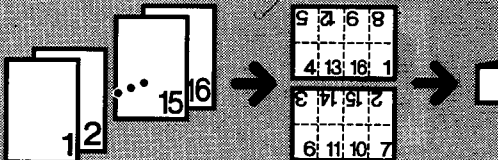

WHAT YOU CAN DO WITH THIS COPIER

Printing Numbers On The Background Of Your Copies

☛ See page 74.

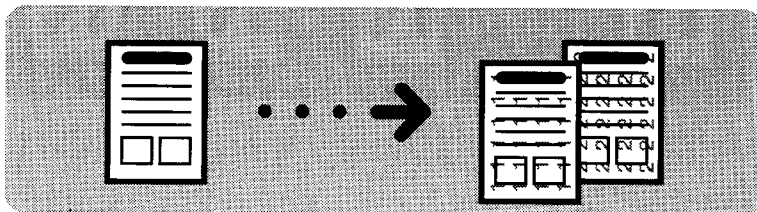

Printing Preset Messages On Your Copies

☛ See page 75.

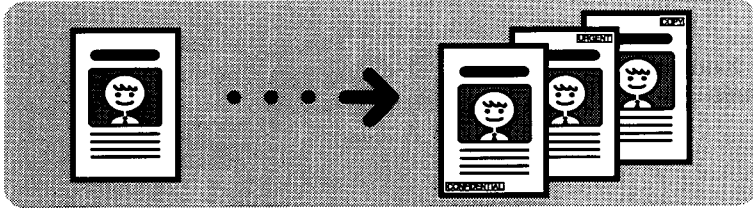

Printing Your Own Messages On Your Copies

☛ See page 79.

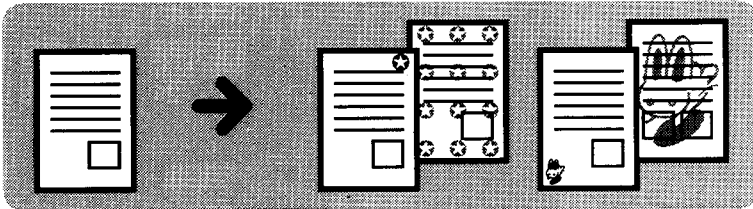

Printing Dates And Page Numbers

☛ See page 81.

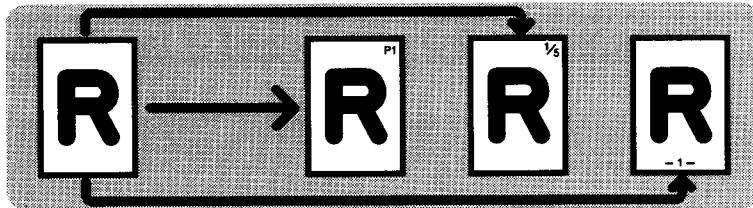
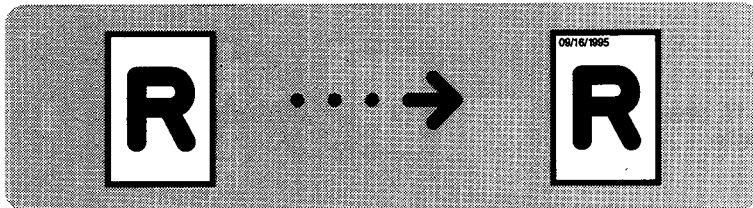

Copying The Image Twice On One Page

☛ See page 86.

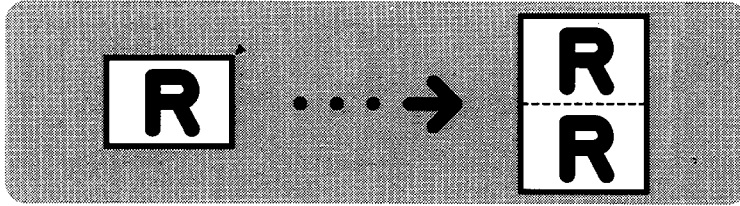

Erasing The Center And The Border (Erase Center/Border)

☛ See page 88.

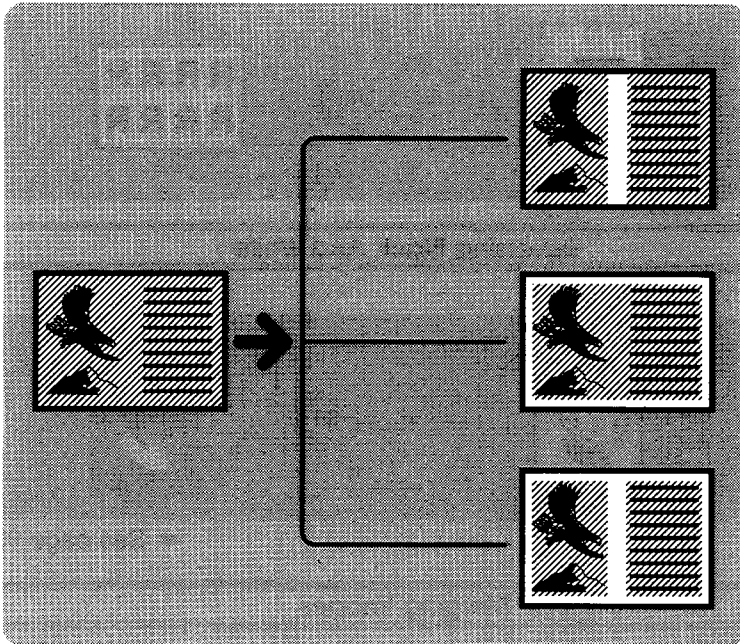

WHAT YOU CAN DO WITH
THIS COPIER

Adjusting The Margin

☛ See page 89.

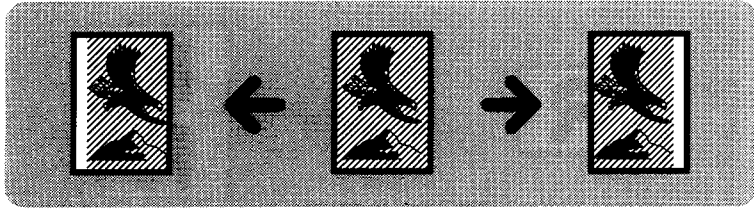

Repeating An Image Over The Entire Copy

☛ See page 91.

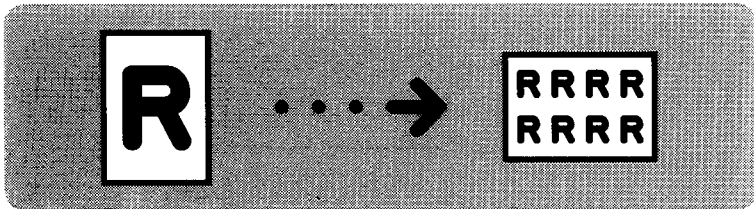

Reversing Black And White

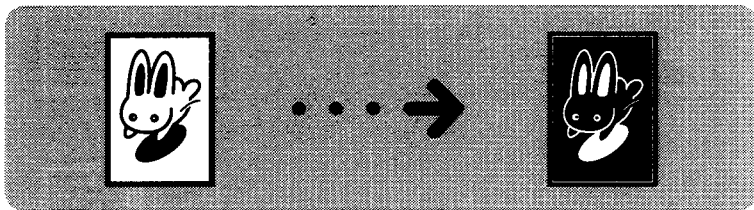

☛ See page 93.

Merging Images

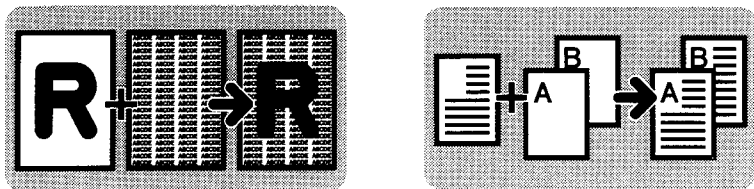

☛ See page 94.

Optional Finishing

Sorting into sets (123, 123, 123)

➔ See page 96.

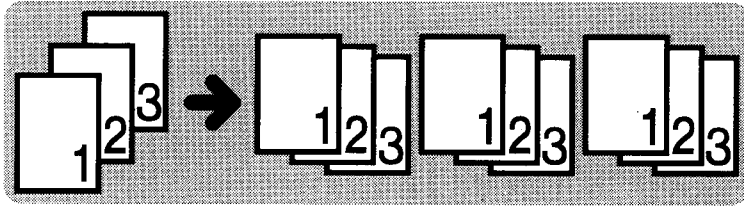

Stapling

➔ See page 100.

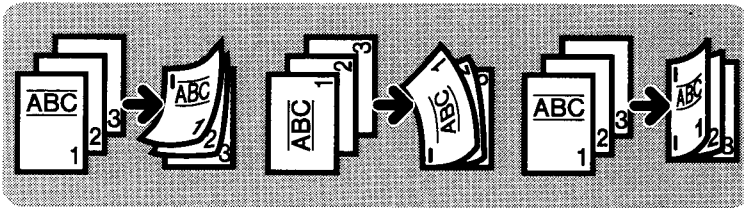

WHAT YOU CAN DO WITH
THIS COPIER

BASICS

STARTING THE COPIER.....	24
When The Main Switch Is In The Stand-by Position	24
When The Display Is Off And The Indicator Of The Clear Modes/Low Power Mode Key Is Lit .	24
When The Copier Is Set For User Codes	25
USING THE TOUCH PANEL DISPLAY.....	26
GETTING HELP ON THE DISPLAY	28
RECOMMENDED & NON-RECOMMENDED ORIGINALS.....	29
Recommended Originals	29
Non-recommended Originals For The Optional Document Feeder	29
SETTING ORIGINALS ON THE EXPOSURE GLASS.....	30
SETTING A STACK OF ORIGINALS IN THE OPTIONAL DOCUMENT FEEDER (ADF).....	30
SETTING ONE ORIGINAL AT A TIME IN THE OPTIONAL DOCUMENT FEEDER (SADF)	32

STARTING THE COPIER

When The Main Switch Is In The Stand-by Position

1 Turn on the main switch.

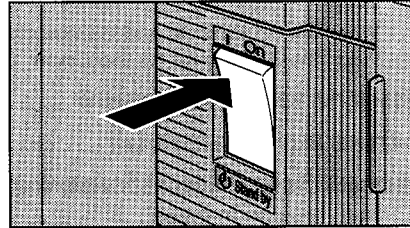

2 Wait for the copier to warm up. During the warm-up period (within 140 seconds), "⏸ Please wait." appears on the display.

3 After warm-up, "⏸ Ready" appears on the display.

When The Display Is Off And The Indicator Of The Clear Modes/Low Power Mode Key Is Lit

The copier is in Low Power mode.

1 Hold down the **Clear Modes/Low Power Mode** key until the indicator is not lit. The machine will return to the standby condition.

☐ For details about Low Power mode, see page 137.

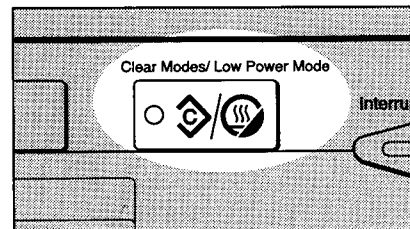

- The following actions will also make the copier ready:
 - ◆ The copier detects anyone operating it.
 - ◆ Opening or closing the optional platen cover.
 - ◆ Opening or closing the optional document feeder.
 - ◆ Setting originals in the optional document feeder.
 - ◆ Opening or closing the bypass tray.
 - ◆ Pressing any key.

When The Copier Is Set For User Codes

- 1** The display instructs you to input your user code, as shown in the illustration.

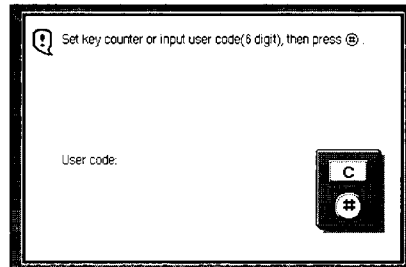

- 2** Input your user code (6 digits) using the **Number** keys.

- To change the entered code, touch the **[C]** key or press the **Clear/Stop** key. Then, enter the new code.

- 3** Touch the **[#]** key or press the **Enter** key.

- To prevent others from making copies with your user code, when you have finished using the machine, hold down the **Clear/Stop** key and press the **Clear Modes/Low Power Mode** key.
- Regarding user codes, see page 140.

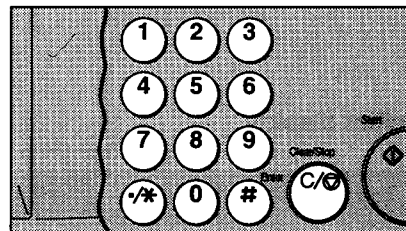

USING THE TOUCH PANEL DISPLAY

On the touch panel display, you can find keys, instructions and messages. By touching keys on the display, you can select or deselect functions and enter data for the selected modes. The display uses the following conventions:

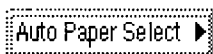

Keys that have the option of being selected.



Keys that have been selected.

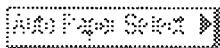

Keys that have no option to select.

In this manual, we use the following convention:

Key on the display:

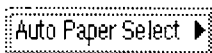

In the manual :

[Auto Paper Select] key

⚠ Caution: *Do not press the touch panel display with any hard or sharp object (pen, pencil, etc.). Always use your fingers or something with a soft tip.*

Initial display

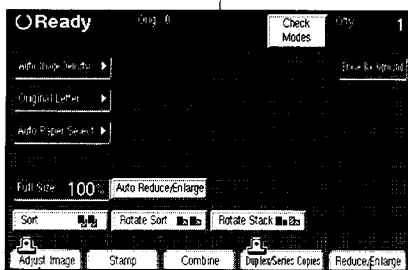

Messages and instructions appears here.

tag sheets

Display after selecting functions on the tag sheets

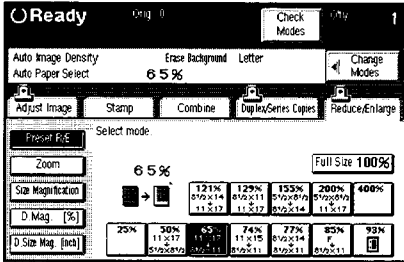

After selecting functions on tag sheets, the clip  appears on the tag.



[Check Modes] key

When you have selected functions on tag sheets, this key appears on the upper right area on the touch panel display. Touch this key to see at a glance all the modes you selected.

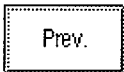

[Prev.] key

This key appears in the upper right corner of the display when you touch the **[Check Modes]** key. Press to go back to the previous display.

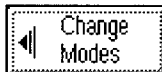

[Change Modes] key

When you select functions on the tag sheets, this key appears on the display. Touch this key to change settings of the following modes:

- image density, original type settings, copy paper size, Auto Reduce\Enlarge, and finishing

GETTING HELP ON THE DISPLAY

Press the **Guidance** key when you want to know detailed information about functions you use.

- 1 Press the **Clear Modes/Low Power Mode** key then the **Guidance** key.

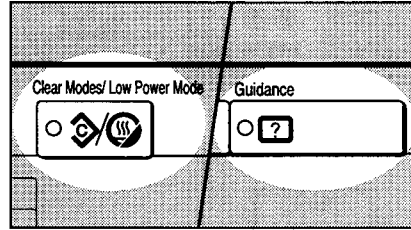

- 2 Touch the key you want to know about on the touch panel display.

For example, if you want to know about "How to operate the display", touch the **[How to operate the display]** key.

- To go to the next page, touch the **[Next]** key. To return to the previous page, touch the **[Prev.]** key.
- To go back to the display shown after pressing the **Guidance** key, touch the **[Menu]** key.
- To exit from the guidance display, touch the **[Exit]** key.

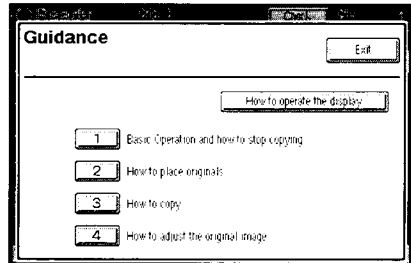

RECOMMENDED & NON-RECOMMENDED ORIGINALS

Recommended Originals

- ❑ Regarding originals that the optional document feeder can handle, see page 169.

Non-recommended Originals For The Optional Document Feeder

⚠ CAUTION: *The following types of originals are not recommended for use with the document feeder. Place them directly on the exposure glass.*

- ❑ Originals thicker than 128 g/m², 34 lb
- ❑ Originals thicker than 105 g/m², 28 lb when using two-sided originals
- ❑ Originals thinner than 40 g/m², 11 lb. But for originals between 40 and 52 g/m² (11 and 14 lb), the document feeder must be set to Thin Paper mode. See page 139.
- ❑ Originals larger than A3, 11" x 17"
- ❑ Originals smaller than A5, 5 1/2" x 8 1/2"
- ❑ Paper with any kind of coating (such as carbon) on the back
- ❑ Folded, curled, creased, or damaged originals
- ❑ Mailing labels, or perforated originals
- ❑ OHP transparencies
- ❑ Translucent paper
- ❑ Pasted originals
- ❑ Damp originals
- ❑ Sticky originals
- ❑ Wavy originals
- ❑ Originals that are not made from paper
- ❑ Originals written in pencil on both sides, or two-sided carbon originals
- ❑ Thermal fax paper, CRO (camera ready original) or aluminum foil
- ❑ Originals with globs of ink from a ball-point pen

SETTING ORIGINALS ON THE EXPOSURE GLASS

- 1** Lift the optional platen cover or the optional document feeder.

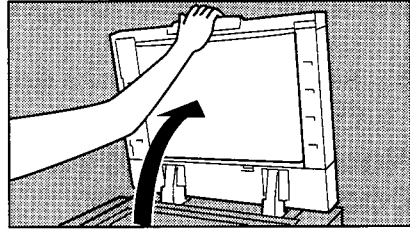

- 2** Set the original *face down* on the exposure glass. The original should be aligned to the rear left corner.

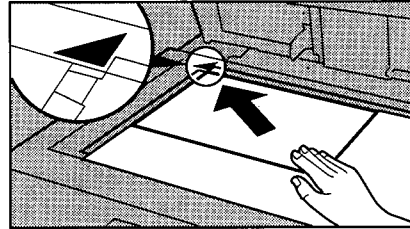

- 3** Lower the optional platen cover or the optional document feeder.

SETTING A STACK OF ORIGINALS IN THE OPTIONAL DOCUMENT FEEDER (ADF)

You can insert a stack of originals (one-sided or two-sided) of the same size into the document feeder. These originals are individually fed onto and removed from the exposure glass.

- If you want to set originals of different sizes at the same time, use the user tools. ➤ See page 151.

- 1** Correct any curl, fold, or crease in the originals before setting.

SETTING A STACK OF ORIGINALS IN THE OPTIONAL DOCUMENT FEEDER (ADF)

2 Confirm that the **Insert Original** indicator is lit before setting the originals.

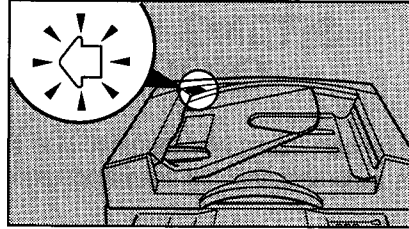

3 Confirm that no previous originals remain on the exposure glass.

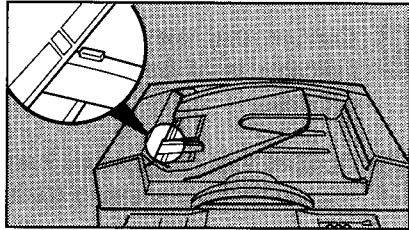

4 Adjust the guide to the original size.

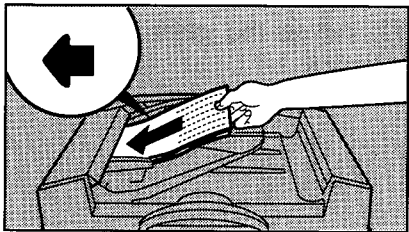

5 Set the originals *face up* into the document feeder until the **Insert Original** indicator goes off.

- The last page should be on the bottom.
- The guide must touch the front side of the originals.

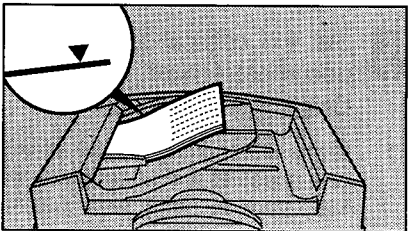

- Do not stack originals above the limit mark.

SETTING ONE ORIGINAL AT A TIME IN THE OPTIONAL DOCUMENT FEEDER (SADF)

You can insert one original at a time into the document feeder. The original is automatically fed onto and removed from the exposure glass.

1 Correct any curl, fold, or crease in the originals before setting.

2 Confirm that the **Insert Original** indicator is lit before setting the originals.

3 Confirm that no previous originals remain on the exposure glass.

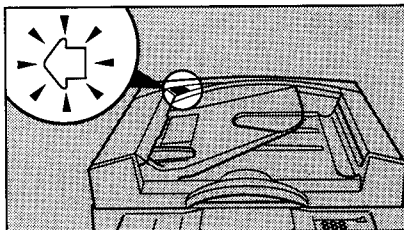

4 Adjust the guide to the original size.

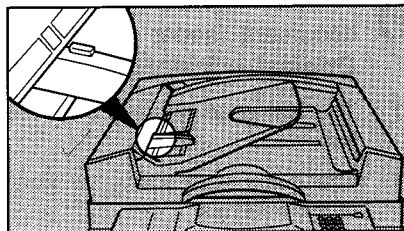

5 Set the original *face up* into the document feeder until the **Insert Original** indicator goes off.

- If you are copying a stack of originals one sheet at a time and you want to keep them in order, start with the last page of the originals.
- The original guide must touch the front side of the original.

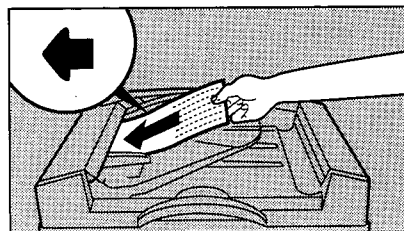

6 Press the **Start** key.

7 While the **Auto Feed** indicator is lit after an original is fed, set the next original. The original is automatically fed and copied.

- If you have set more than two originals, the **Auto Feed** indicator is not lit after the last original is fed. In this case, press the **Start** key again after setting an original.

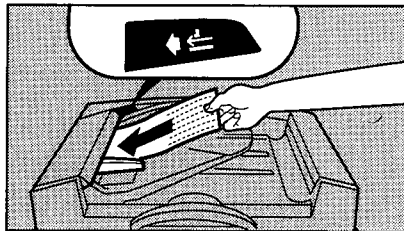

SETTING ONE ORIGINAL AT A TIME IN THE OPTIONAL DOCUMENT FEEDER (SADF)

COPYING

BASIC OPERATIONS.....	36
One-to-one Copying (Full Size Copying)	36
Entering Copy Job Settings During The Warm-up Period (Auto Start)	37
Adjusting Copy Image Density	37
Selecting The Copy Paper Size (Manual Paper Select)	38
Having The Copier Choose The Paper Size(Auto Paper Select)	39
Having The Copier Choose The Reproduction Ratios (Auto Reduce/Enlarge).....	41
Selecting Original Type Setting (Letter, Letter/Photo, Photo, Generation Copy)	43
Sorting Into Sets (123,123,123) (Sort, Rotate Sort).....	44
Stacking Together All Copies Of A Page (111,222,333) (Rotate Stack)	48
Copying From The Bypass Tray	50
Temporarily Stopping One Job To Copy Something Else (Interrupt)	53
Recalling Job Settings (Job Recall)	53
Storing Your Copy Setting In Memory (Program).....	54
REDUCING AND ENLARGING (Reduce/Enlarge)	55
Reducing And Enlarging Using Preset Ratios (Preset R/E)	55
Reducing And Enlarging In 1% Steps.....	56
Fitting The Original To A Copy Of A Different Size	58
WORKING WITH BOTH SIDES OF ORIGINALS AND COPIES (Duplex/Series Copies).....	61
Making Two-sided Copies (Duplex)	61
Making One-sided Copies (Series Copies)	68
COMBINING ORIGINALS INTO ONE COPY (Combine)	70
PRINTING ID NUMBERS, PAGE NUMBERS, AND MESSAGES (Stamp)	74
Printing Numbers On The Background Of Your Copies (Background Numbering)	74
Printing Preset Messages On Your Copies (Auto Stamping) - English Only.....	75
Printing Your Own Messages On Your Copies (User Stamping).....	79
PRINTING ID NUMBERS, PAGE NUMBERS, AND MESSAGES (Stamp)	79
Printing Dates And Page Numbers (Date Stamping, Page Numbering)	81
EDITING THE COPY IMAGE (Adjust Image).....	86
Copying The Image Twice On One Page (Double Copies)	86
Erasing The Center And The Border (Erase Center/Border)	88
Adjusting The Margin (Margin Adjustment)	89
Repeating An Image Over The Entire Copy (Image Repeat).....	91
Reversing Black and White (Positive/Negative).....	93
Merging Images (Overlay/Merge).....	94
OPTIONAL FINISHING	96
Sorting Into Sets (123,123,123) (Sort)	96
Stapling (Staple)	100
Stapling Position And Original Setting	101
When Setting One Original At A Time	104
When Setting A Stack Of Originals In The Document Feeder	104
COMBINATION CHART	105

BASIC OPERATIONS

One-to-one Copying (Full Size Copying)

You can make copies that are the same size as your originals.

- ❑ Duplex mode (from an even number of one-sided originals to two-sided copies in Top to Top orientation) and Margin Adjustment (0.2" width right margin for the back side) are default settings. If you want to change these settings, touch the **[Duplex/Series Copies]** and **[Adjust Image]** keys. You can change the default settings with the user tools. ➤ See pages 141 and 143.

1 Set your original on the exposure glass or in the optional document feeder. ➤ See pages 30 ~ 33.

2 Enter the number of copies required using the **Number** keys.

- ❑ To change the number entered, press the **Clear/Stop** key, then enter the new number.

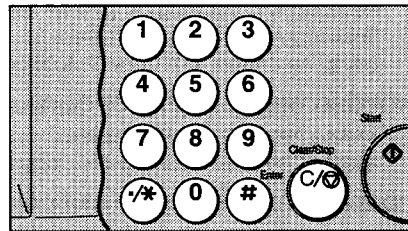

3 Confirm that the **[Auto Paper Select]** key is dark. If not, touch the **[Auto Paper Select]** key, or select the proper paper size using keys on the display.

- ❑ Regarding Auto Paper Select, ➤ see page 39.
- ❑ Regarding selecting paper size, ➤ see page 38.

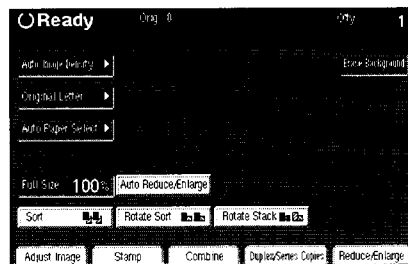

4 Make sure that the **[Full Size]** key is dark. If not, touch it.

5 Press the **Start** key.

- ❑ To stop the copier during the multi-copy run, press the **Clear/Stop** key.
- ❑ Press the **Start** key to resume copying, or press the **Clear/Stop** key to clear the entered copy number.

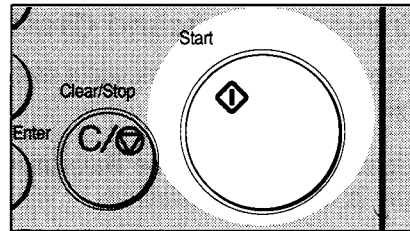

Entering Copy Job Settings During The Warm-up Period (Auto Start)

During the warm-up period (within 140 seconds), the display is as shown. If you enter your copy job settings and press the **Start** key during the warm up period, the copier will start copying automatically when the copier reaches the ready condition.

- ❑ To cancel Auto Start, press the **Clear/Stop** key.

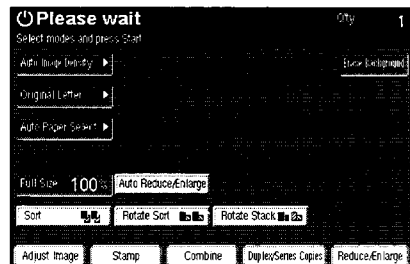

Adjusting Copy Image Density

Auto and manual image density

If the **[Auto Image Density]** key is dark, Auto Image Density is selected. If not, touch the **[Auto Image Density]** key.

If the **[Auto Image Density]** key is light, Manual Image Density mode is selected. To get a darker image, touch the **[Darker]** key. To get a lighter image, touch the **[Lighter]** key.

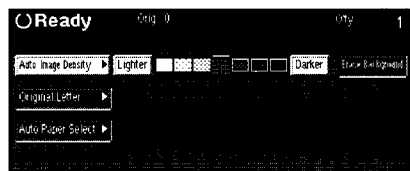

Erasing Background (Erase Background)

Use this mode to mask out a dirty background (e.g. with a newspaper) and get clear copies.

Confirm that the **[Erase Background]** key is dark. If not, touch it.

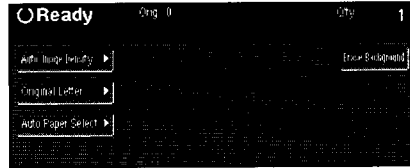

Selecting The Copy Paper Size (Manual Paper Select)

You can select the desired copy paper size manually by touching one of the tray keys in the display.

- Regarding setting copy paper in the bypass tray, see page 50.
- The keys that have an * (asterisk) cannot be used for Auto Paper Select.

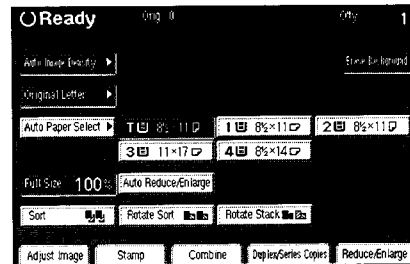

Having The Copier Choose The Paper Size (Auto Paper Select)

The copier selects a suitable size of copy paper based on the original size and the reproduction ratio. Make sure that the **[Auto Paper Select]** key is dark. If not, touch the **[Auto Paper Select]** key.

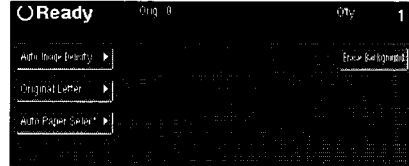

- ❑ If you use translucent or transparent originals or originals with tags, the original size might not be detected correctly.
- ❑ When placing the original on the exposure glass directly, make sure that the optional platen cover or optional document feeder is lowered before pressing the **Start** key. Otherwise, the original size might not be detected correctly.
- ❑ When the original is set at a different direction from the copy paper in the paper tray and the required paper size is A4, 8 1/2" x 11" or smaller, the copier automatically rotates the original image by 90° to match the copy paper direction and make copies.
- ❑ The tray keys that have an * (asterisk) cannot be used for the Auto Paper Select.
- ❑ Regarding the combination of the Auto Paper Select and Stapling, see page 101.
- ❑ Regarding functions that cannot be used together with this function, see page 105.
- ❑ Duplex mode (from an even number of one-sided originals to two-sided copies in Top to Top orientation) and Margin Adjustment (0.2" width right margin for the back side) are default settings. If you want to change these settings, touch the **[Duplex/Series Copies]** and **[Adjust Image]** keys. You can change this default setting with the user tools. See pages 141 and 143.

BASIC OPERATIONS

- ☐ When you use Auto Paper Select, refer to the following table for possible copy paper sizes

Metric version

Original	Possible selected paper sizes for copy
A or B type*	A or B type*
8" x 13"	8" x 13"***, A or B type*
8 1/4" x 13"	8 1/4" x 13"***, A or B type*
8 1/2" x 13"	8 1/2" x 13"***, A or B type*
LT type**, 8" x 10"	LT type**, 8" x 10", A or B type*

* :A type (A3, A4, A5), B type (B4, B5, B6)

** :LT type: 11" x 17", 8 1/2" x 11"

*** :F/F4 size selected by user tools. ☛ See page 138.

Inch version

Original	Possible selected paper sizes for copy
LT type	LT type
A4	A4, LT type
8" x 13"	8" x 13"**, LT type
8 1/4" x 13"	8 1/4" x 13"**, LT type
8 1/2" x 13"	8 1/2" x 13"**, LT type
11" x 15", 10" x 14", 8" x 10"	11" x 15", 10" x 14", 8" x 10", LT type

* :LT type: 11" x 17", 8 1/2" x 14", 8 1/2" x 11", 5 1/2" x 8 1/2"

** :F/F4 size selected by user tools. ☛ See page 138.

Having The Copier Choose The Reproduction Ratios (Auto Reduce/Enlarge)

The copier can choose an appropriate reproduction ratio based on the paper and original sizes you select.

- ❑ If you use translucent or transparent originals or originals with tags, the original size might not be detected correctly.
- ❑ When placing the original on the exposure glass directly, make sure that the optional platen cover or optional document feeder is lowered before pressing the **Start** key. Otherwise, the original size might not be detected correctly.
- ❑ When the original is set at the different direction from the selected copy paper, the copier *cannot* rotate the image by 90°. Make sure to set the original in the same direction as the copy paper.
- ❑ Regarding functions that cannot be used together with this function, see page 105.
- ❑ Duplex mode (from an even number of one-sided originals to two-sided copies in Top to Top orientation) and Margin Adjustment (0.2" width right margin for the back side) are default settings. If you want to change these settings, touch the **[Duplex/Series Copies]** and **[Adjust Image]** keys. You can change this default setting with the user tools. See pages 141 and 143.

Example:

Metric version: Original: A3, Copy paper: A4
 Inch version: Original: 11" x 17", Copy paper: 8 1/2" x 11"

1 Touch the **[Auto/Reduce Enlarge]** key.

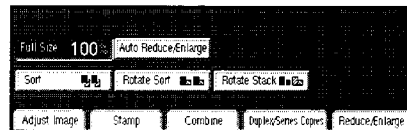

COPYING

BASIC OPERATIONS

2 Set your original on the exposure glass or in the optional document feeder. See pages 30 ~ 33.

3 Select the copy size you require:

Metric version:

Touch the **[A4]** paper tray key.

Inch version:

Touch the **[8 1/2" x 11"]** paper tray key.

4 Press the **Start** key. The original image is reduced to fit the selected copy paper.

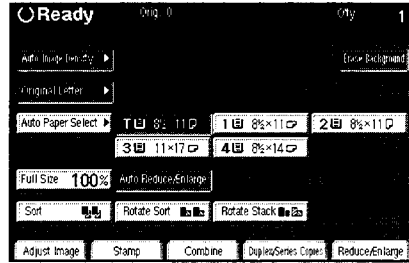

Selecting Original Type Setting (Letter, Letter/Photo, Photo, Generation Copy)

There are four types of original type setting. Select the appropriate original type to match the kind of originals you are copying from.

- ❑ Letter mode is the default. You can change this setting using the user tools.
 - See page 141.

Letter

Select Letter mode when your originals contain only letters (no picture).

Letter/Photo

Select Letter/Photo when your originals contain photographs or pictures with letters.

Photo

Delicate tones of photographs and pictures can be reproduced with this mode.

Generation copy

If your originals are copies, so called generation copies, the copy image can be reproduced sharply and clearly.

- 1 Letter mode is selected by default. Select the desired setting by touching one of four keys.

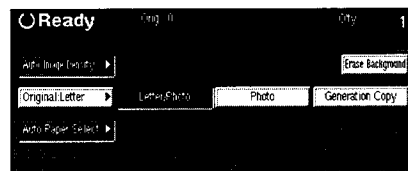

Sorting Into Sets (123,123,123) (Sort, Rotate Sort)

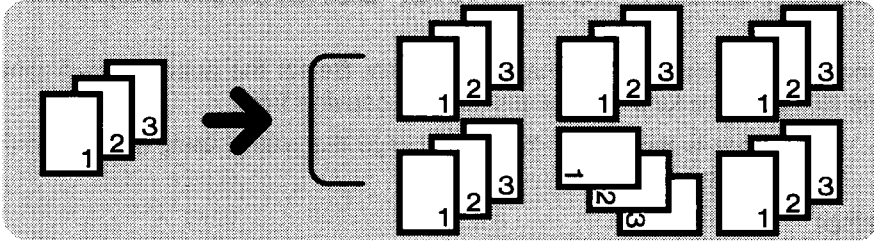

The copier puts images of more than two originals into memory and copies are collated into sets. In Sort mode, every copy set is delivered on the copy tray. In Rotate Sort mode, every other copy set is rotated by 90° and delivered to the copy tray, so that each set can be easily separated.

Notes for above modes

- ❑ You can make up to 999 copy sets at a time. However, when the number of copies exceeds the capacity of the copy tray, remove copies from the copy tray. Regarding the capacity of the copy tray, see page 166.
- ❑ After starting copying, the only setting you may change is image density. The change will apply from the next copy. See page 37.
- ❑ The maximum number of pages that can be stored is as follows:
A4, 8 1/2" x 11": Approximately 100 pages (images)
- ❑ You can change the settings of these modes with the user tools. See page 151.
- ❑ Regarding functions that cannot be used together with this function, see page 105.
- ❑ Duplex mode (from an even number of one-sided originals to two-sided copies in Top to Top orientation) and Margin Adjustment (0.2" width right margin for the back side) are default settings. If you want to change the modes, touch the [Duplex/Series Copies] and [Adjust Image] keys. You can change this default setting with the user tools. See pages 141 and 143.

Notes for Rotate Sort mode

- ❑ Paper sizes that can be used in Rotate Sort mode are as follows:
A4, B5, 8 1/2" x 11"
- ❑ Two paper trays that are identical in size and different in direction are required. You can change this setting using the user tools. See page 151.
- ❑ This mode does not support different size originals.

Notes for Sort mode

- When you make two-sided copies in Sort mode, the maximum number of copies stacked in the unit for two-sided copies (duplex unit) is as follows:

A3, 11" x 17":	30 sheets
Other sizes:	50 sheets
- Different size originals can be used only when you make one-sided copies from one-sided originals.

- 1** Touch the [**Sort**], or [**Rotate Sort**] key.

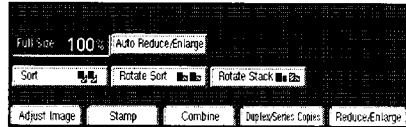

- 2** Enter the number of copy sets with the **Number** keys.

3 When setting one original at a time

- 1** Set an original on the exposure glass or in the optional document feeder (see page 30 or 32). Then press the **Start** key. The copier starts memorizing the original image.
 - Start with the last page to be copied.
- 2** When the **Start** key turns green, or the **Auto Feed** indicator on the document feeder is lit, set the next original. If you have set the original on the exposure glass in step **1**, press the **Start** key.
 - Set the original in the same direction as step **1**.
 - When the memory reaches 0%, the copier stops memorizing. Press the **Start** key to finish copy jobs which are already into memory. After that, follow the instructions on the display.
- 3** Repeat step **2** until all originals are scanned.
- 4** After all originals are put into memory, press the **Enter** key.
 - If you are making one-sided copies, the first set of copies will have completed.
- 5** Press the **Start** key.

3 When setting a stack of originals in the document feeder

- ❶ Set a stack of the originals in the document feeder (☛ see page 30), then press the **Start** key.
 - ☐ The last page should be on the bottom.
 - ☐ When memory runs out during copying, the machine can be programmed to behave in two ways with the user tools.
 - ◆ Memory Full Auto Scan Restart = **[Yes]**
 - After all images in memory are copied, the machine will re-start scanning automatically.
You should re-order your copies after all copy jobs are finished.
 - ◆ Memory Full Auto Scan Restart = **[No]**
 - The machine will wait for you to press the **Start** key. At this point you should remove your copies from the copy tray. Press the **Start** key and then follow the instructions on the display to continue copying.

If you want to change the setting with the user tools, ☛ see page 151.

- ☐ If you make one-sided copies, the first set of copies has been completed when all original images are stored in the memory.

Stopping storing images and deleting stored images during copying

- 1** Press the **Clear/Stop** key.
 - The copying run of the 1st set and scanning will stop.
- 2** Press the **Clear/Stop** key again. If you want to delete stored images, touch the **[Yes]** key following the instructions on the display.
 - You cannot delete the stored images by press the **Clear/Stop** key, if copies have been stacked in the unit for two-sided copies (duplex unit) when making two-sided copies. In this case, after the step **1**, press the **Clear Modes/Low Power Mode** key. So that, all settings and stored images will be cleared. Then remove copies in the duplex unit by opening the front cover. For position of the duplex unit, see page 4.

Stacking Together All Copies Of A Page (111,222,333) (Rotate Stack)

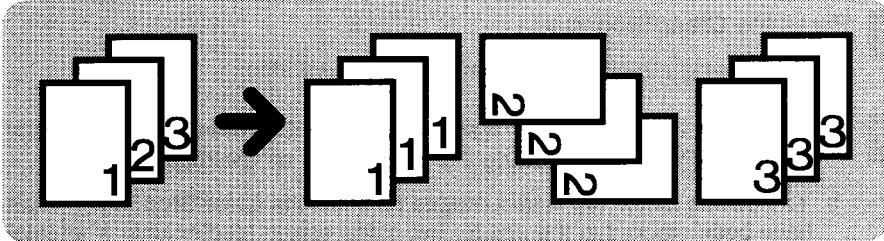

Each original is copied together. Every other copies is delivered to the copy tray, turned 90°.

- ❑ You can make up to 999 copy sets at a time. However, when the number of copies exceeds the capacity of the copy tray, remove copies from the copy tray. Regarding the capacity of the copy tray, see page 166.
- ❑ These modes do not support different size originals.
- ❑ After starting copying, the only setting you may change is image density, The change will apply from the next copy. See page 37.
- ❑ Two paper trays that are identical in size and different in direction are required. You can change this setting with the user tools. See page 151.
- ❑ The paper sizes that can be used in the Rotate Stack mode is as follows:
A4, B5, 8 1/2" x 11"
- ❑ Regarding functions that cannot be used together with this function, see page 105.
- ❑ Duplex mode (from an even number of one-sided originals to two-sided copies in Top to Top orientation) and Margin Adjustment (0.2" width right margin for the back side) are default settings. If you want to change the modes, touch the **[Duplex/Series Copies]** and **[Adjust Image]** keys. You can change this default setting with the user tools. See pages 141 and 143.